

MODEL  
DLx1500  
1500lb/680kg CAPACITY  
PULLING WINCH

FRONT & SIDE VIEW

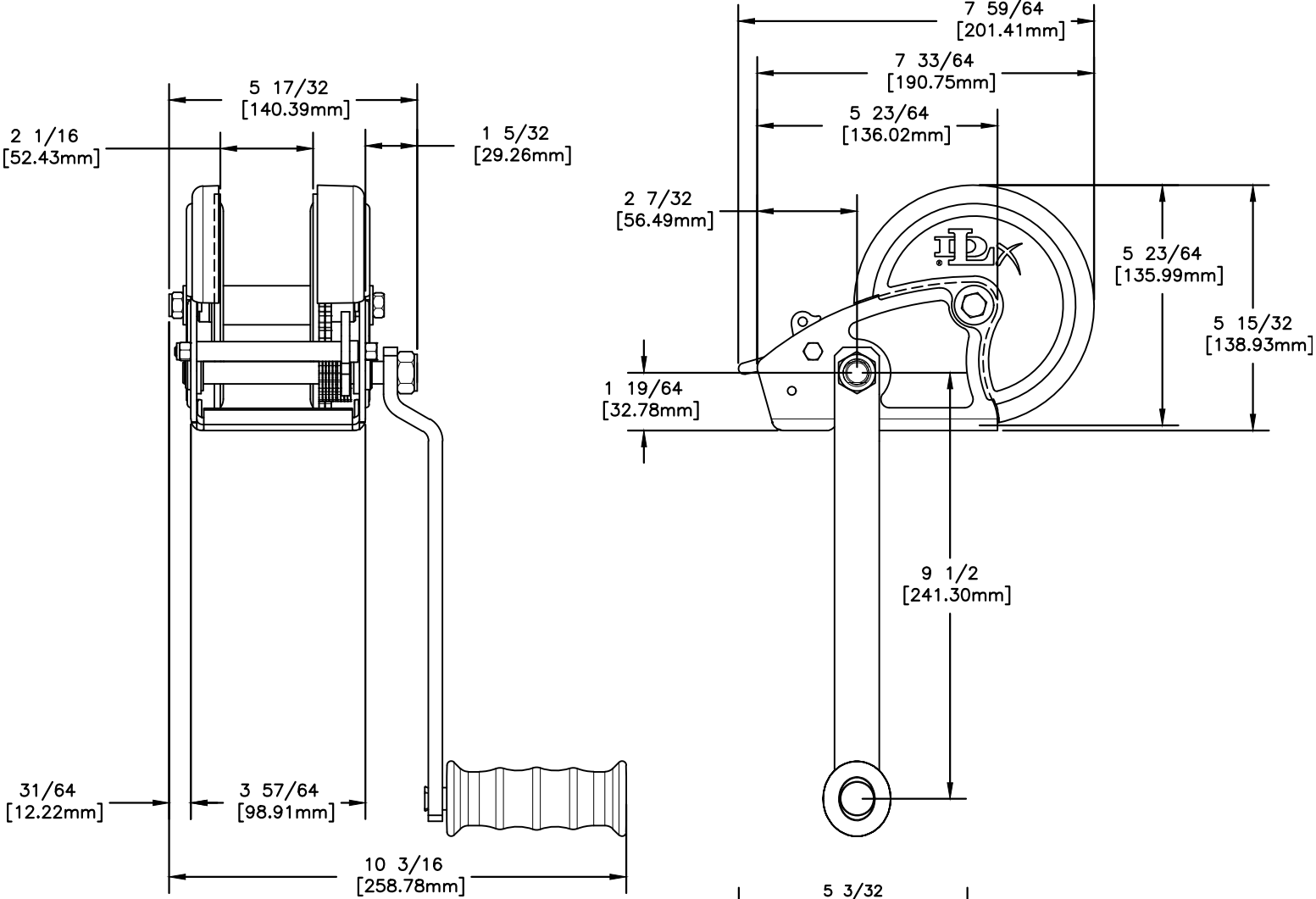

BASE HOLE PATTERN

